

230V SWING GATE KIT FOR A PAIR OF GATES

Up to 400kg @ 5m or up to 1000kg @ 2m per leaf



Code	Description	Quantity
801MP-0200	Irreversible gearmotor for swing gates up to 3m per leaf.	2
801QA-0130	ZLX230S - Multi-function control panel for single and double leaf swing gates. Equipped with a graphic programming display, self-diagnosing safety devices, digital torque control DTC, 4 settable safety inputs, BUS CXN and 1000 storable users.	1
001AF43S	Plug-in radio-frequency control card	1
806TS-0270	TOP44FGN - Four-channel 433.92 MHz fixed code transmitter.	2
001TOP-A433N	Tuned Antenna.	1
001DIR10	Pair of 12 - 24 V AC - DC outdoor photocells – range 10 m.	1



801MP-0200

Gate leaves of up to 5 m

The next generation motor for swing gates, combining robust construction with maximum efficiency

- The aluminium structure, engineered with optimised couplings, minimises vibration and offers exceptional resistance to extreme environmental conditions, operating reliably from -20°C to +55°C with an IP54 protection rating.
- Every ATI unit undergoes thorough post-assembly inspection and testing before shipment to guarantee maximum reliability.
- ATI is highly versatile, with models suitable for leaves up to 3 meters and 800 kg, and up to 5 meters and 1000 kg. It can be easily adapted for installation on large posts, accommodating a C-MAX of up to 155 mm.
- With a force of 4000N, ATI delivers outstanding power and speed, achieving a 90° opening in just 13 seconds.



Dimensions (mm)



Application (mm)



Refer to the diagram in the manual to determine the dimensions of A and B and the best fixing position.

Application Dimension (mm)

801MP-200	
E	C Max.
920	155

Technical characteristics

MODELS	801MP-0200
Protection rating (IP)	54
Motor power supply (V)	230 AC 50/60 Hz
Power (W)	220
Maneuvering time 90° (s)	19
Cycles/hour	23
Thrust (N)	400 to 4000
Operating temperature (°C)	-20 to +55
Colour	RAL 7024

ZLX230S

Control panel



Control panel for 230V gearmotors

- Multi-function control panel in special 230 V version for single and double leaf swing gates. Equipped with a graphic programming display to ensure the installer can read the complete menu items and follow the wizard. It also has self-diagnosing safety devices, digital torque control DTC, 4 settable safety inputs, BUS CXN and 1000 storable users.
- Equipped with a timer function for configuring up to 8 different time slots and up to 16 special days.

Dimensions (mm)

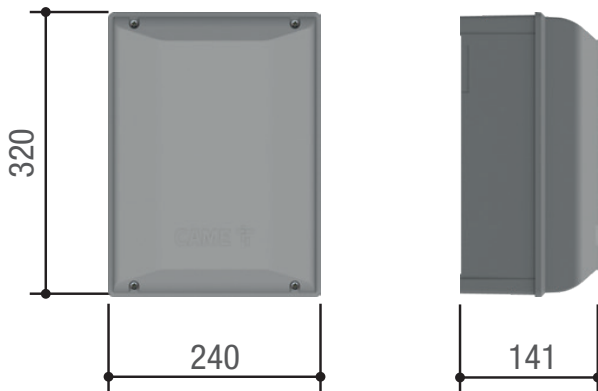

Technical characteristics

MODEL	801QA-0130
Protection rating (IP)	54
Power supply (V - 50/60Hz)	230 AC
Motor power supply (V)	230 AC
Power (W)	1100
Operating temperature (°C)	-20 to +55
RAL color	7024
Cabinet material	ABS

ACCESSORIES

TOPA433N

Tuned Antenna for 433.92Mhz



Dimensions (mm)

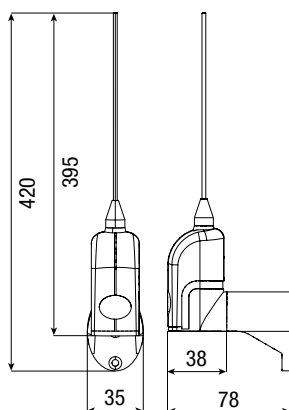

Operational limits

MODELS	TA433N
Max. range of radio (m)	50 ÷ 150

Technical characteristics

MODELS	TA433N
Radio signal frequency (Mhz)	433.92Mhz

AF43S

Radio frequency control card 433.92MHz

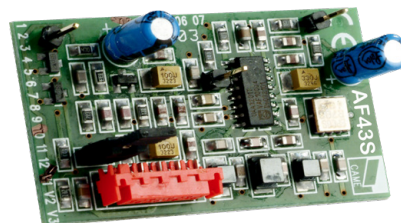

- Dip-switches for code and function selection
- Function enabling button
- Red signalling LED
- Green signalling LED
- Backup board
- Plug-in connector on receivers

Technical characteristics

MODELS	AF43S
Power supply (V±10%)	5
Current draw (mA)	5.5
Encoding type	ASK
Operating temperature (°C)	-20 to +55
Sensitivity (dBm)	-107

TOP44RBN

Rolling code 433.92 radio control



- Self-learning from transmitter to transmitter.
- Self-learning from TOP, TAM and TWIN series radio controls.
- More secure thanks to the dynamic code for the rolling code version.
- It can be configured remotely via gateway or locally via GAME KEY.

Dimensions (mm)



Operational limits

MODELS	806TS-0270
Max. range of radio (m)	50 ÷ 150

Technical characteristics

MODELS	806TS-0270
Combinations	4.294.967.896
Radio signal frequency (Mhz)	433,92
Operating temperature (°C)	-20 ÷ +55
Material	POLYCARBONATE

DIR10

Photocells



- Control the gate's area of movement
- Infrared beam, even synchronised, to prevent any external signal disturbances.
- For the DIR series photocells, there is a double-height post, and a new PVC version of the post, for installing in entry and exit points where heavy vehicles drive through.
- High degree of protection against weathering.

Dimensions (mm)

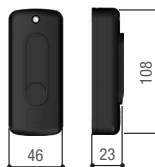

Operational limits

MODELS	DIR10
Max. range of radio (m)	10

Technical characteristics

MODELS	DIR10
Protection rating (IP)	54
Power supply (V)	12 - 24 AC - DC
Absorption	60
Max. rating of 24 V (A) relay contacts	0,5
Operating temperature (°C)	-20 ÷ +55
Material	ABS - POLYCARBONATE